



eFlex Single RackEnd Barrier

Designed to protect the end of racking aisles where turning vehicles and equipment can impact vulnerable racking structures.

The Single Rail version will absorb and deflect repeated contact from vehicles with lower centres of gravity, preventing damage to racking systems.

The circular end posts provide enhanced protection at the barrier ends which are most susceptible to impact. Innovative spinning collars further deflect and dissipate impact forces.



Unrivalled recovery through a unique built-in memory that allows the barrier to flex, cushion and reform repeatedly upon impact, saving vast amounts in barrier and vehicle repairs.

Huge return on Investment from incident prevention and downtime avoidance as rails, vehicles, floors and infrastructure do not need replacing or repair.

Features and benefits



Self coloured and UV stabilised for continued high visibility and long lasting aesthetics with no repainting.



Rotating wear collars deflect force from repeat glancing blows preventing expensive on-going maintenance costs.



Memaplex™ advanced strength polymer created from an exclusive composition of the most sophisticated polyolefins and rubber additives, expertly blended for unequalled strength and flexibility.

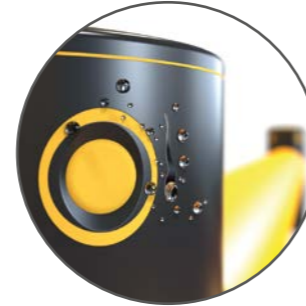

Ultra-low maintenance material is chemical and water resistant, non-corrosive, non-scratch and self coloured so no repainting, rusting, flaking or corrosion.

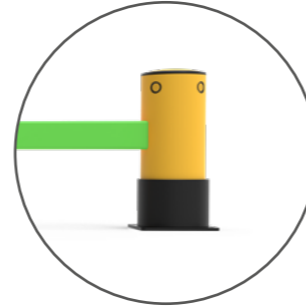

Environmentally friendly and 100% recyclable.

Suitability

Vehicle

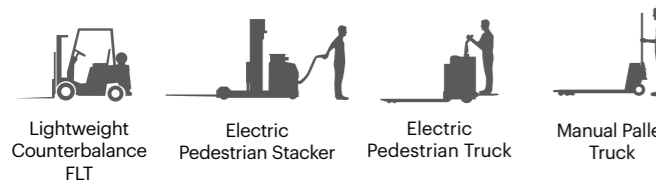

Application



Racking Protection

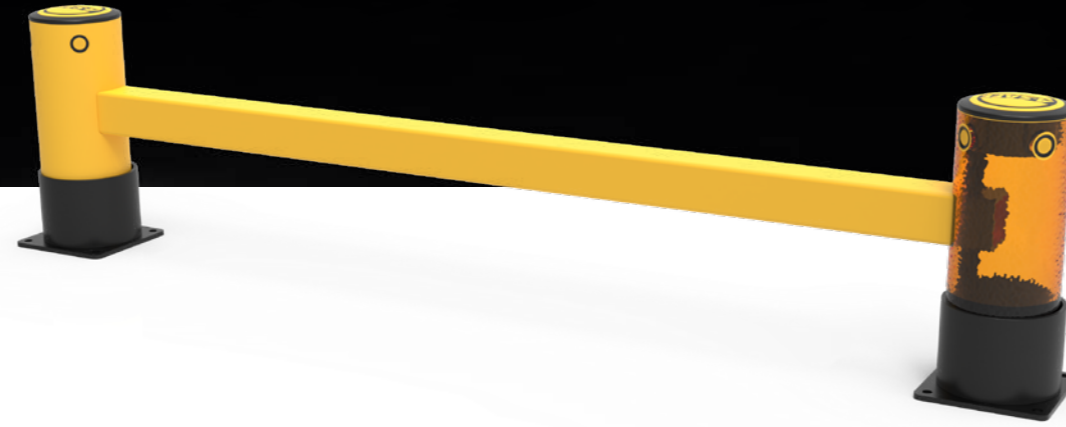

Technical Information

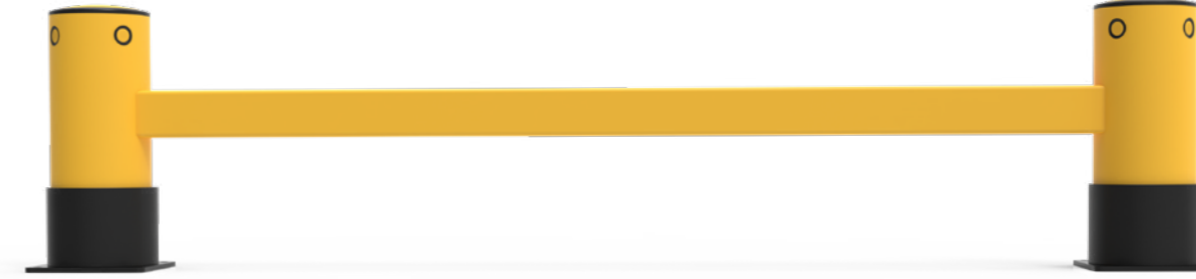

Dimensions (mm)

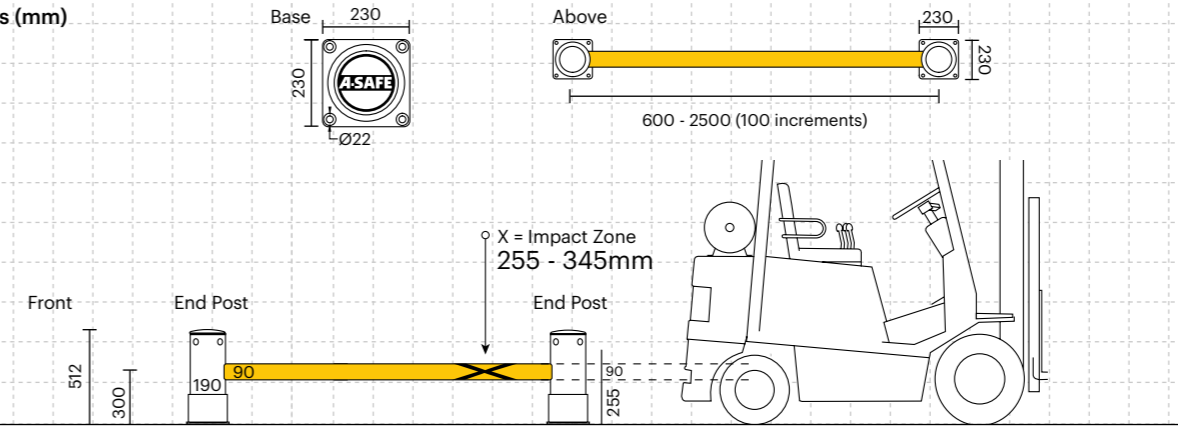

Colour Combinations



*Please note that the RAL and PANTONE colours listed are the closest match to standard A-SAFE colours, but may not be exact matches of the actual product colour and should be used for guidance only.

Impact Test	Impact Angle on 2000mm Post Centres			
	90°	67.5°	45°	22.5°
Mid Rail Max Energy (Joules)	4,000	4,686	8,000	27,314

End Post Max Energy (Joules) - 90°	3,600
------------------------------------	-------

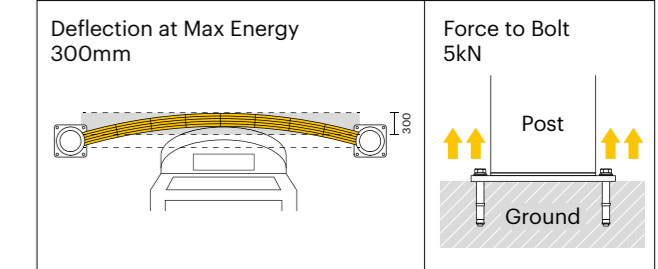

Material Properties	MEMAPLEX™
Temperature Range	-10°C to 50°C
Ignition Temperature	370°C to 390°C
Flash Point	350°C to 370°C
Toxicity	Not Hazardous
Chemical Resistance	Excellent - ISO/TR 10358
Weathering Stability (Grey Scale)	5/5*
Light Stability (Blue Wool Scale)	7/8**
Static Rating (Surface Resistivity)	1015 - 1016 Ω
Hygiene Seals	No

* Weathering scale 1 is very poor and 5 is excellent
** Light stability scale 1 is very poor and 8 is excellent

A-SAFE UK Ltd
Ainley House, Ainleys Industrial Estate, Elland, Halifax, HX5 9JP, United Kingdom
www.asafe.com

